

REMER

RUBINETTERIE

SERIE
SERIES

COMPONENTI DOCCIA SHOWER COMPONENTS

CODICE
CODE

337M

IMMAGINE - IMAGE



DESCRIZIONE - DESCRIPTION

Preso acqua in ottone cromato, con supporto per doccia.
Per flessibile da 1/2" con attacco conico.

C.p. brass wall water punch and shower holder with conical nut,
for 1/2" flexible hose.

SCHEDA TECNICA - TECHNICAL FEATURES

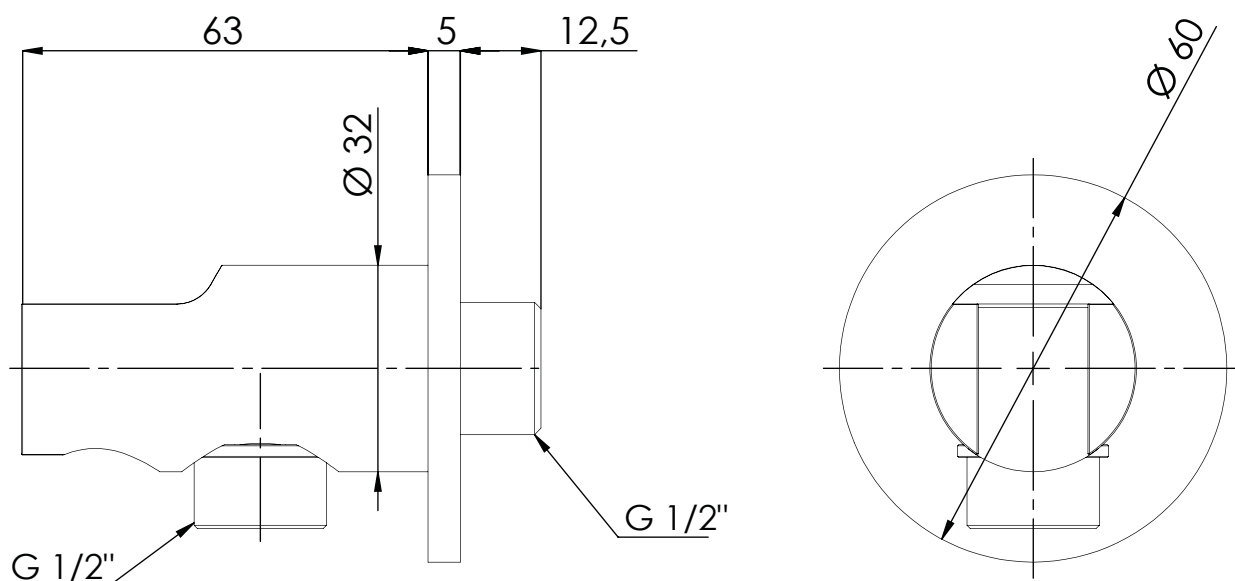









CARATTERISTICHE - FEATURES



Disponibile in Finitura
Available in Finishing

FINITURE - FINISHING

 NO Nero Opaco Matt Black	 NP Nichel Spazzolato Brushed Nickel	 DO Oro Lucido Shiny Gold	 CFP Cromo Nero Spazzolato Brushed Black Chrome
 BO Bianco Opaco Matt White	 NPO Nichel Spazzolato Opaco Matt Brushed Nickel	 BG Oro Spazzolato Brushed Gold	 CR Cromo Chrome

REMER Rubinetterie S.p.A.

Via Leonardo Da Vinci, 83 - 20062 Cassano d'Adda (MI) - Italy - Tel. +39 0363 364211 - info@remer.eu - www.remer.eu