

# REMER

## RUBINETTERIE

SERIE  
SERIES

# SLASH & DOT

CODICE  
CODE

# SLO9HRG

### IMMAGINE - IMAGE

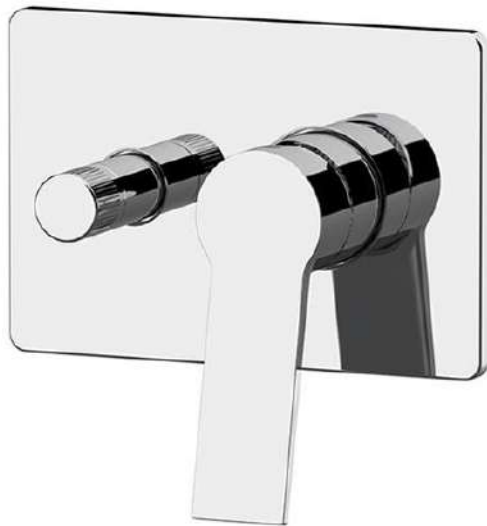

### SCHEMA TECNICA - TECHNICAL FEATURES

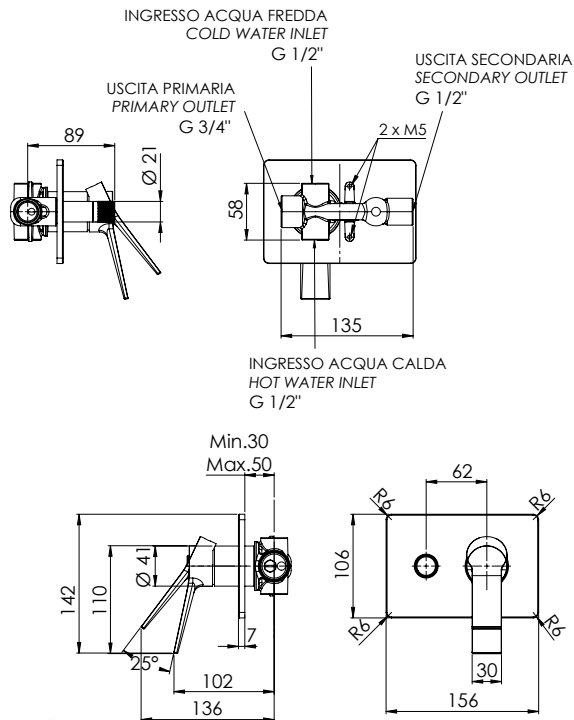





### DESCRIZIONE - DESCRIPTION

Miscelatore a incasso per vasca/doccia con deviatore a 2 vie con vitone ceramico, su piastra rettangolare, montaggio orizzontale. Per selezionare l'uscita desiderata, la manopola del deviatore deve essere ruotata da una posizione all'altra.

Built-in bath/shower mixer with 2-way diverter with ceramic head valve, on rectangular plate, horizontal mounting. To select the desired output, the diverter knob must be turned from one position to the other.

### FINITURE - FINISHING

	<b>NO</b> Nero Opaco Matt Black		<b>BO</b> Bianco Opaco Matt White
	<b>NP</b> Nichel Spazzolato Brushed Nickel		<b>XV</b> Visual Steel Visual Steel
	<b>DO</b> Oro Lucido Shiny Gold		<b>BG</b> Oro Spazzolato Brushed Gold
	<b>CR</b> Cromo Chrome		

### COMPONENTI - COMPONENTS



Cartuccia R52AP  
Cartridge R52AP

### CARATTERISTICHE - FEATURES



Disponibile in Finitura  
Available in Finishing



2 Vie  
2 Ways

FLOW RATE [L/MIN]-G1/2"  
FREE DISCHARGE

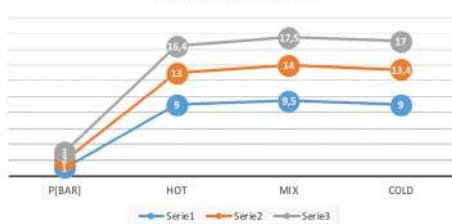

FLOW RATE [L/MIN]-G3/4"  
FREE DISCHARGE



REMER Rubinetterie S.p.A.

Via Leonardo Da Vinci, 83 - 20062 Cassano d'Adda (MI) - Italy - Tel. +39 0363 364211 - info@remer.eu - www.remer.eu