



**DANIEL**

SCHEDA TECNICA TECHNICAL FEATURES

ART. COD.

**DV5022**

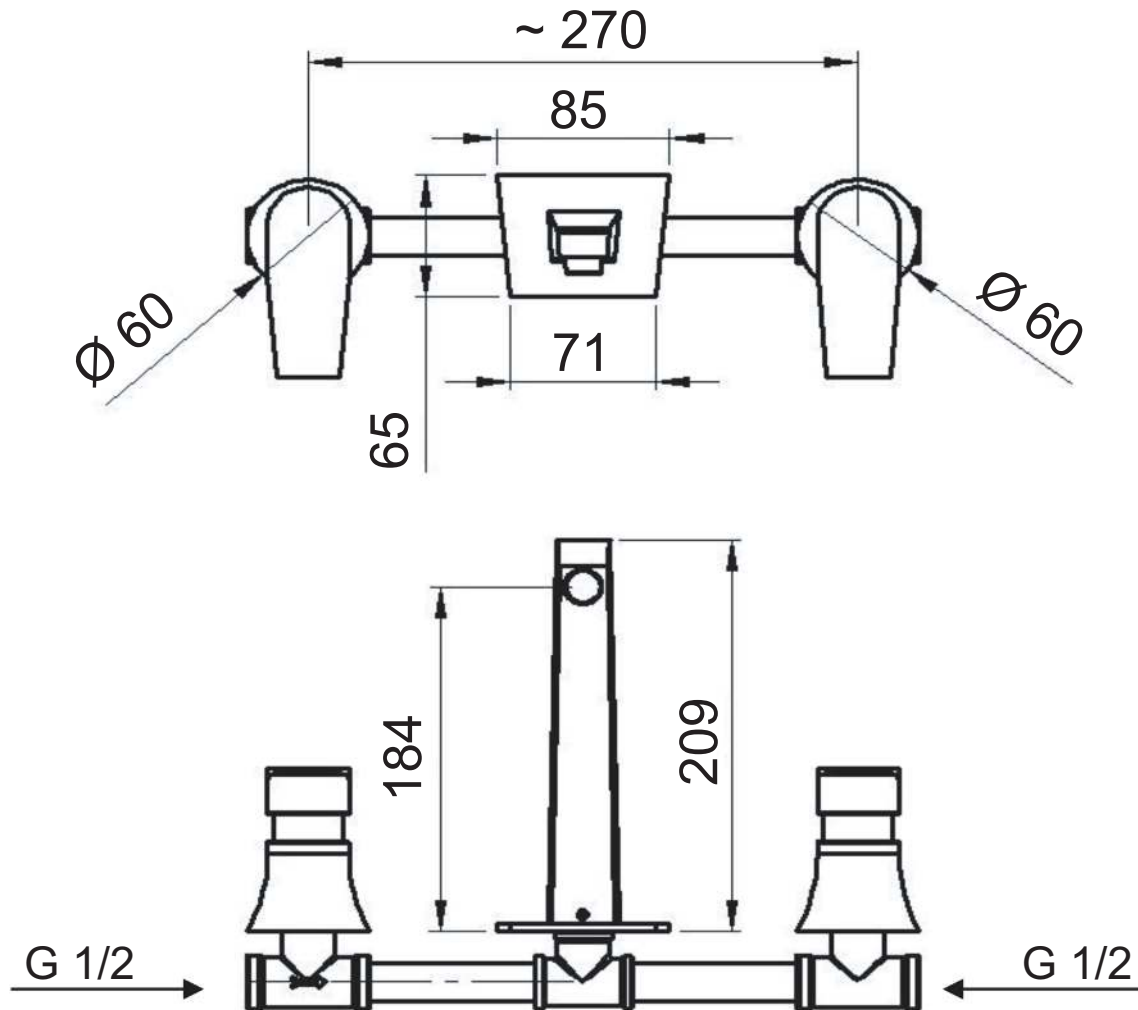

**MATERIALI / MATERIALS**

OTTONE CROMATO / CHROME PLATED BRASS

**CROMATURA / CHROME PLATING**

UNI EN 248