

REMER

RUBINETTERIE

SERIE
SERIES

INFINITY

CODICE
CODE

109S080

IMMAGINE - IMAGE



SCHEMA TECNICA - TECHNICAL FEATURES

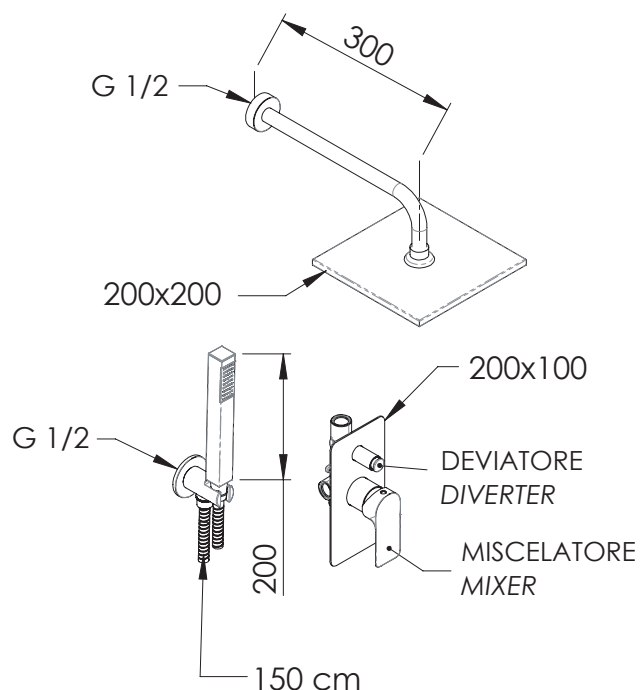

DESCRIZIONE - DESCRIPTION









Set doccia composto da: soffione doccia in ottone cm 20x20, con getti in silicone soffice anticalcare (modello 359SS), braccio tondo in ottone cm 30; incasso doccia con deviatore; supporto/presa acqua fisso in ottone; doccetta anticalcare in ottone a 1 funzione, flessibile in ottone 150. Disponibile in finitura.

Shower set, including: brass shower head 20x20 cm with antilimestone soft silicone jets (item: 359SS), brass arm cm 30; built-in shower mixer with diverter; shower holder/water punch in brass, 1 function handshower in brass, flexible hose in brass cm 150. Finishing options available.

FINITURE - FINISHING



CARATTERISTICHE - FEATURES

- | | | | |
|---|---|---|--|
|  | Disponibile in finitura Available in Finish |  | Getto intenso a risparmio idrico Intense water-saving jet |
|  | 2 Vie 2 Ways |  | Getto Aerato Intenso Intense Aerated Jet |
|  | Flessibile Lungo 150 cm Flexible Length 150 cm |  | Getto Esterno External Jet |
|  | Con Getti Anticalcare With Antilimestone Jets | | |
|  | Getto spray ampia copertura e getto intenso esterno a risparmio idrico Wide coverage spray jet and intense water saving external jet | | |

COMPONENTI - COMPONENTS



REMER Rubinetterie S.p.A.

Via Leonardo Da Vinci, 83 - 20062 Cassano d'Adda (MI) - Italy - Tel. +39 0363 364211 - info@remer.eu - www.remer.eu